

# LumiLink

## DALI-2 CV PWM Driver



The perfect companion for your LED strip or Flex projects.

The LumiLink DALI Constant Voltage PWM dimmer is a four channel device that uses a single DALI address and can be configured to run 4 channels of single colour (all controlled as one group), 2 channels of tunable white (controlled as one group), RGB or RGBW Constant voltage LED.

The unit can accept a wide range of voltage inputs and is rated at up to 5A per channel.

Pair with our LumiLink power supplies for the complete solution!

## Features

- 1-4 channel CV DALI PWM Dimmer
- Uses a single DALI address
- DALI-2 certified
- DALI logarithmic dimming curve
- Over-load / short circuit protection with automatic recovery
- Single colour, Tunable White, RGB or RGBW Control

## Technical Specifications

### Input and Output

Input voltage:	12-48VDC
Input current:	20.5A
Output current:	4x5A@12/24V 4x3A@36/48V
Output Power:	4 x 60W @12V 4x120W@24V 4 x 108W@36V 4x144W@48V

### Environment

Operation temperature:	Ta: -20 C ~ +55 C
Protection:	IP20

### Dimming Data

Input signal:	DALI
Dimming Range:	0 - 100%
Dimming Curve:	Logarithmic
PWM Frequency:	2000Hz

### Package

Size:	L178 x W50 x H38mm
Gross weight:	0.14kg



technical details subject to change rev v1.2

## Example of Use

● For single color

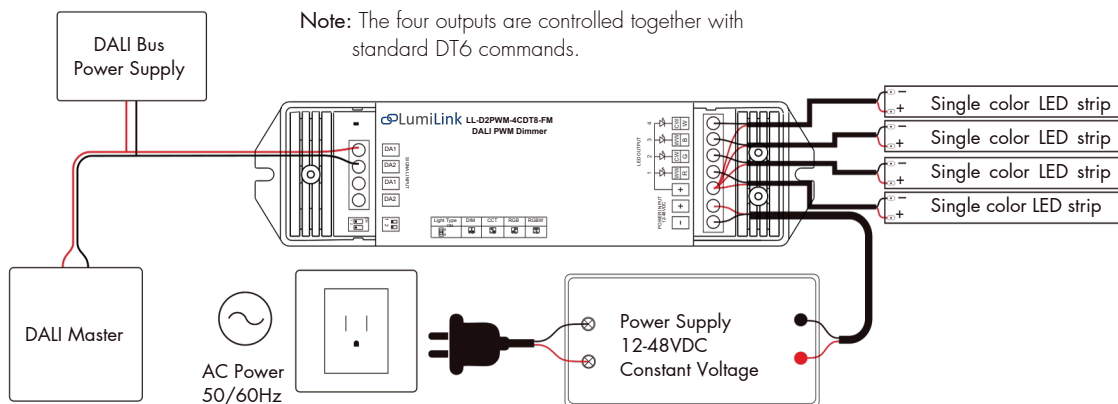

● For dual color (TW)

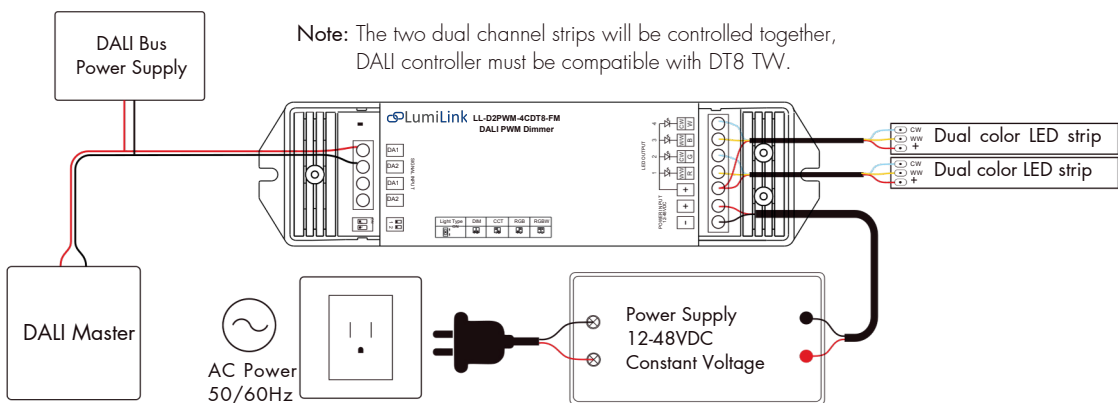

● For RGBW

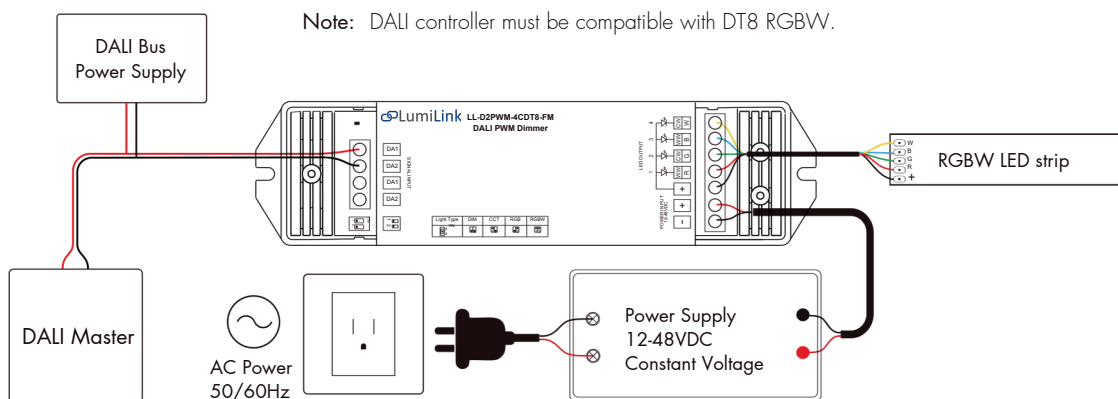

## Ordering Information

Part Number	Description
LL-D2PWM-4CDT8-FM	LumiLink DALI PWM Dimmer, 4 Channel DT8, Field Mount

To find out more about LumiLink products, scan this QR code:



technical details subject to change rev v1.2